

2024

Hylumen Lighting

Innovation in Lighting



LEADING MANUFACTURER OF
OUTDOOR, INDOOR & COMMERCIAL
LED LIGHTING

www.hylumen.com
www.hylumen.in



Catalogue : 2024

Hylumen Industries

DELHI, ODISHA, WESTBENGAL, ASSAM

hylumen@hylumen.com. Mo: 0091-8908029390/7854870502



BIS CERTIFIED LED LIGHT MANUFACTURER



hylumen@hylumen.com
www.hylumen.com





Brief Introduction



Hylumen is well recognized brand name in LED Lighting since its inception in 2010. **An ISO 9001:2015 Certified** organizations is a pioneer in the field of LED based Lighting Systems and has been engaged in **manufacturing and exporting of LED based Lighting Systems** .

- ❖ We are **MSME Registered** and Registered supplier on Government Procurement Portal **GEM**.
- ❖ We use **LM 80 Certified Premium LED** which gives 140 lumens/Watt along with
- ❖ We use **BIS Marked Driver** with inbuilt surge protection 6KVA for our Light.
- ❖ We give **100% Replacement Guarantee for two years**, Not Warrantee
- ❖ We ourselves or through our dealer are **present locally** to you for any issues you may face.
- ❖ Our products have life span of 50000 to 100000 Hrs.
- ❖ Our Products are **CE, ROHS, ISO certified**.
- ❖ Our **Make in India** product Wattage **rating is lab tested**.

Our Mission

Our Mission is to satisfy the customers with innovative Products & Solutions. Our aim is to introduce energy saving products on regular intervals and always live up to the reputation. To facilitate the Consumer with the best of Energy Saving Products.

Our Vision

Our vision is to contribute towards making our country "ATMANIRBHAR" and participate in enhancing the concept of "MAKE IN INDIA". To make our Country Proud in the International Forum by providing the best indigenous products. To keep our Consumer happy with the services & quality. To give an environment of Peace, Growth and Prosperity to all who are associated with the Company.

Advantage of Hylumen LED

- Long life
- Energy efficiency
- High brightness and intensity
- Exceptional color range
- Low radiated heat
- Instantaneous illumination
- Reliability
- Directional lighting



Company Profile



Hylumen is well recognized brand name in LED Lighting. An ISO Certified organization is a pioneer in the field of LED based Lighting Systems and has been engaged in manufacturing and exporting of LED based Lighting Systems, Consumer goods and other Industrial Products. The company is managed by the team of professionals from Electronics and Lighting Industry whose only goal is to design and manufacture world class lighting products. Our products are precisely manufactured as per the highest electrical specifications to ensure highest performance, aesthetics as well as functionality. With this, in a short span of time we have been able to deliver our services to some of the most well-known and discerning clients in India and have set up a strong reference list of clients and projects. We are one of the largest manufacturers of LED Lighting products in India. We have manufacturing facilities in Nagpur Maharashtra & Bhubaneswar Odisha with complete infrastructure for R&D, Manufacturing and Testing.

Our Strength

Make in India

All Hylumen products are designed and manufactured in India to the highest standards. We're so confident in them that all of our products come with a 2 year warranty. Hylumen and all of our products are also ISO, CE & ROHS certified along with BIS Driver

We are committed to Technology

All Hylumen products combine cutting edge technologies with the highest levels of quality to deliver outstanding performance and reliability. Our philosophy is innovation & illumination and we will always look to lead lighting trends in the market.

We are the Lighting Experts

Hylumen and all our people are 100% focused on lighting. Everything from product design, manufacturing, pre-sales, lighting design and after sales service is under one roof at our HQ so information is shared and absorbed easily. We believe in developing our staff to becoming leaders.

We are Passionate about the Environment

We have a true Green Philosophy. Both Hylumen products and features within the products are designed to save energy, save electrical costs and reduce Co2 usage.

Range of Products

Industrial Products: Flood Light, Street Light, High Bay Light, Well Glass Light & Solar Street Light

Indoor Products: Panel Light, Surface Light, Tube Light

Outdoor Products: Bollard Light, Gate Light, Garden Spike Light

Commercial Products: Profile Lighting, LED Strip, SMPS





LED FLOOD LIGHT

LED FLOOD LIGHT DOWN CHOKE (HYSLFL)						
Wattage	30 Watt(30W)	50 Watt(50W)	60 Watt(60W)	100 Watt(100W)	120 Watt(120W)	150 Watt(150W)
	200 Watt(200W)			300 Watt(300W)		
LED FLOOD LIGHT BACK CHOKE(HYBCFL)						
Wattage	50 Watt(50W)	100 Watt(100W)	150 Watt(150W)	200 Watt(200W)	300 Watt(300W)	400 Watt(400W)
LED LENS FLOOD LIGHT(HYLENFL)						
Wattage	50 Watt(50W)			100 Watt(100W)		
LED FLOOD LIGHT RGB (with Remote)(HYRGBFL)						
Wattage	50 Watt(50W)			100 Watt(100W)		
LED COLOUR FLOOD LIGHT(HY FL100W)						
Wattage	100 watt	Colour	RED(RD)	GREEN(GR)	BLUE(BL)	PINK(PK)

LED FLOOD LIGHT	
Input Voltage	110V -285V AC
Auto Cut off	310V
Over Voltage Protection	440V
Power Consumption	As per wattage selected
Lumens	140 Lumens/Watt
LED Life	>50000 Hrs.
Colour Temperature(WH)	6500 K
Colour Temperature(WW)	2700-3500 K
Colour Index (CRI)	>80%
Beam Angle	120 Degree
Protection	Short Circuit, Open Circuit
THD	<=10 %
Power Factor	>0.95%
Electronic Efficiency	>=85%
Working Temperature	-40°C to + 80°C
Surge Withstand	6 KVA
Connecting Cable	3 Core
Driver	
Mounting	Internal
Size	96*35*25mm
Qty	As per wattage selected
Optical Parameter	
LED Brand	OSRAM/ EDISON/ CREE
LED Source	SMD LED
Current	1500 ma
No of LED	As per Wattage
Housing Parameter	
Shape	Rectangular
Protection	IP66
Glass	4mm Toughened Glass
Material	Aluminium Die Cast





LED STREET LIGHT

LED GLASS STREET LIGHT(HYGLSL-)						
Wattage	18 Watt(18W)	24Watt(24W)	36 Watt(36W)	36 Watt Eco(36WE)	40 Watt(40W)	50 Watt(50W)
	50 Watt Eco(50WE)	60 Watt(60W)	72 Watt(72W)	72 Watt Eco(72WE)	100 Watt(100W)	150 Watt(150W)
LED LENS STREET LIGHT(HYLESL)						
Wattage	24 Watt(24W)	36 Watt(36W)	50 Watt(50W)	60 Watt(60W)	72 Watt(72W)	100 Watt(100w)

LED STREET LIGHT	
Input Voltage	110V -285V AC
Auto Cut off	310V
Over Voltage Protection	440V
Power Consumption	As per wattage selected
Lumens	140 Lumens/Watt
LED Life	>50000 Hrs.
Colour Temperature(WH)	6500 K
Colour Temperature(WW)	2700-3500 K
Colour Index (CRI)	>80%
Beam Angle	120 Degree
Protection	Short Circuit, Open Circuit
THD	<=10 %
Power Factor	>0.95%
Electronic Efficiency	>=85%
Working Temperature	-40°C to + 80°C
Surge Withstand	6 KVA
Connecting Cable	3 Core
Driver	
Mounting	Internal
Size	As per wattage selected
Qty	As per wattage selected
Optical Parameter	
LED Brand	OSRAM/ EDISON/ CREE
LED Source	SMD LED
Current	1500 ma
No of LED	As per Wattage
Housing Parameter	
Shape	Rectangular
Protection	IP66
Glass	4mm Toughened Glass
Material	Aluminium Die Cast





LED HIGHBAY LIGHT



LED HIGH BAY LIGHT (Surge Protection available up to 10 Kva on demand) (HYHB-)	
Wattage	100 Watt (100W) 120 Watt (120W) 150 Watt(150W) 200 Watt (200W) 300 Watt (300W) 360 Watt (360W)
LED HIGH BAY LIGHT	
Input Voltage	110V -285V AC
Auto Cut off	310V
Over Voltage Protection	440V
Power Consumption	As per wattage selected
Lumens	140 Lumens/Watt
LED Life	>50000 Hrs
Colour Temperature(WH)	6500 K
Colour Temperature(WW)	2700-3500 K
Colour Index (CRI)	>80%
Beam Angle	120 Degree
Protection	Short Circuit, Open Circuit
THD	<= 10 %
Power Factor	>0.95%
Electronic Efficiency	>=85%
Working Temperature	-40°C to + 80°C
Surge Withstand	6 KVA
Connecting Cable	3 Core
Driver	
Mounting	Internal
Size	As per wattage selected
Qty	As per wattage selected
Optical Parameter	
LED Brand	OSRAM/ EDISON/ CREE
LED Source	SMD LED
Current	1500 ma
No of LED	As per Wattage
Housing Parameter	
Shape	Rectangular
Protection	IP66
Glass	4mm Toughened Glass
Material	Aluminium Die Cast





LED WELL GLASS LIGHT

LED WELL GLASS LIGHT(HYWG-)			
Wattage	30 Watt(30W) 36 Watt(36W) 50 Watt(50W) 60 Watt(60W) 72 Watt(72W) 100 Watt(100w)		
LED WELL GLASS LIGHT			
Input Voltage	110V -285V AC	Driver	
Auto Cut off	310V	Mounting	Internal
Over Voltage Protection	440V	Size	As per wattage selected
Power Consumption	As per wattage selected	Qty	As per wattage selected
Lumens	140 Lumens/Watt	Optical Parameter	
LED Life	>50000 Hrs	LED Brand	OSRAM/ EDISON/ CREE
Colour Temperature(WH)	6500 K	LED Source	SMD LED
Colour Temperature(WW)	2700-3500 K	Current	1500 ma
Colour Index (CRI)	>80%	No of LED	As per Wattage
Beam Angle	120 Degree	Housing Parameter	
Protection	Short Circuit, Open Circuit	Shape	Rectangular
THD	<=10 %	Protection	IP66
Power Factor	>0.95%	Glass	4mm Toughened Glass
Electronic Efficiency	>=85%	Material	Aluminium Die Cast



LED INDOOR LIGHT (PANEL LIGHT, SURFACE LIGHT, TUBELIGHT)

LED SLIM PANEL LIGHT(HYSLP-)				
Wattage	6 Watt(8W)	12 Watt(15W)	18 Watt(18W)	22 Watt(22W)
LED SURFACE PANEL LIGHT(HYSLSP-)				
Wattage	6 Watt(8W)	12 Watt(15W)	18 Watt(18W)	22 Watt(22W)
LED PC PANEL LIGHT(HYPCP-)				
Wattage		8 Watt(8W)	15 Watt(15W)	22 Watt(22W)
LED PC RING FOR PANEL(HYPCR-)				
Wattage		8 Watt(8W)	15 Watt(15W)	22 Watt(22W)
LED T8 TUBELIGHT PLASTIC(HYPCTL-)				
Wattage				36 Watt(36W)

LED INDOOR LIGHT	
Input Voltage	AC 85 – 265V, 50Hz
Colour Temperature(WH)	6500 K
Colour Temperature(WW)	2700-3500 K
IP Level	IP20
Shape	SQUARE/ROUND
LED Chip	2835
Colour Index (CRI)	80
Certification	CE, Rohs, ISO
Mounting Type	Recessed/Surface
Surge Protection	>2Kv
Operating Temperature	Ta – 50°C Tc – 70°C



- WIDE BEAM ANGLE
- 3 YEARS WARRANTY
- SAVE UP TO 80% ENERGY
- UP TO 50,000 BURNING HOURS
- HIGH LUMENS
- FLICKER PROOF
- ANTI-GLARE LIGHT
- 2.5 SURGE PROTECTION
- Service After Warranty
- Trusted Brand





DECORATED LIGHT (LED FLEXIBLE STRIP, ROPE LIGHT & PROFILE LIGHT)

LED STRIP & ROPE LIGHT				
Model No	Length	Specification	Colour	MRP
HYRP573072	36/50 Mtr	5730 SMD 72 LED ROPE	WH,WW,RD,BL	135
HYRP573072C	36/50 Mtr	5730 SMD 72 LED ROPE	GR,PK	150
HYRP573072RGB	36 Mtr	5730 SMD 72 LED ROPE	Colour Changing	200
HYST240	5 Mtr	2835 240 LED STRIP	WH,WW,RD,BL	115
HYST240C	5 Mtr	2835 240 LED STRIP	GR,PK	115
HYST5M120	5 Mtr	2835 120 LED STRIP -5 mm	WH,WW	270

LED PROFILE LIGHT			
Model No	Size & Specification	Std Length	MRP
HYPRL8M	8mm collar and Without collar	3 Mtr	225
HYPRL13M	13 mm collar and Without collar	3 Mtr	270
HYPRL17M	17 mm collar and Without collar	3 Mtr	340
HYPRL25M	25 mm collar and Without collar	3 Mtr	450
HYPRL3520M	35*20 collar and Without collar	3 Mtr	1125
HYPRL5020M	50*20 collar and Without collar	3 Mtr	1575
HYPRL7520M	75*20 collar and Without collar	3 Mtr	2250

LED SMPS		
Model No	Power	MRP
HYSMP2A	2 Amp	560
HYSMP5A	5 Amp	1100
HYSMP10A	10 Amp	1800
HYSMP30A	30 Amp	4500



Universal U-shape series All accessories included

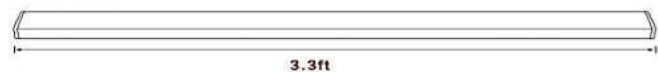
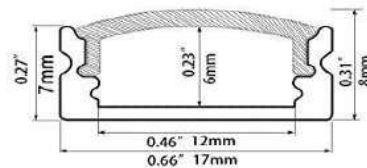

Accessories for each pack (for silver channel)





SLIM PANEL



6500K 4000K 3000K

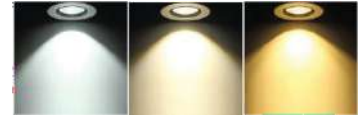

90-100 LW/W	BIS DRIVER	SKD SUPPLIER	2.5KV PROTECTION
----------------	---------------	-----------------	---------------------

■ PF.9PF.6

- WARRANTY-2YEARS
- MATERIAL -
- AluminiumSHAPE -
- Round/SquareBEAMING
- ANGLE-120°
- LEDCHIP-BRIDGELUXSMD0.2W
- BODYCOLOR-White/Black

SPECIFICATION

8W

WATT-8W
 DIMENSION OUTER(MM)-120mm
 DIMENSION CUTOUT(MM)-100mm
 COLOR TEMPERATURE-6500K,4000K,3000K
 LUMENS-720
 LED QUANTITY-40

18W

WATT-18W
 DIMENSION OUTER(MM)-195mm
 DIMENSION CUTOUT(MM)-175mm
 COLOR TEMPERATURE-6500K,4000K,3000K
 LUMENS-1620
 LED QUANTITY-90

12W

WATT-12W
 DIMENSION OUTER(MM)-145mm
 DIMENSION CUTOUT(MM)-125mm
 COLOR TEMPERATURE-6500K,4000K,3000K
 LUMENS-1080
 LED QUANTITY-60

22W

WATT-22W
 DIMENSION OUTER(MM)-220mm
 DIMENSION CUTOUT(MM)-200mm
 COLOR TEMPERATURE-6500K,4000K,3000K
 LUMENS-1980
 LED QUANTITY-110

15W

WATT-15W
 DIMENSION OUTER(MM)-170mm
 DIMENSION CUTOUT(MM)-150mm
 COLOR TEMPERATURE-6500K,4000K,3000K
 LUMENS-1350
 LED QUANTITY-75

30W

WATT-30W
 DIMENSION OUTER(MM)-300mm
 DIMENSION CUTOUT(MM)-275mm
 COLOR TEMPERATURE-6500K,4000K,3000K
 LUMENS-2400
 LED QUANTITY-150



100

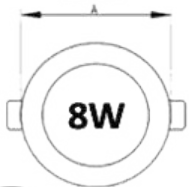

8W

125

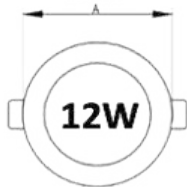

12W

150

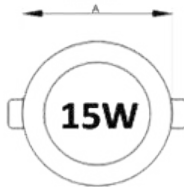

15W

175

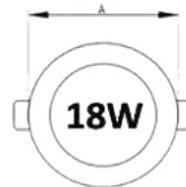

18W

200

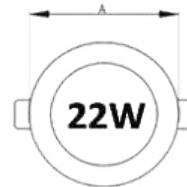

22W



100*100

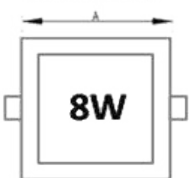

8W

125*125

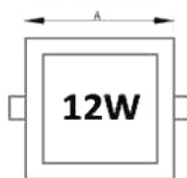

12W

150*150

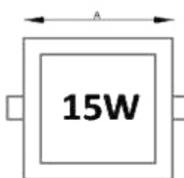

15W

175*175

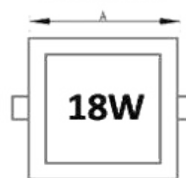

18W

200*200

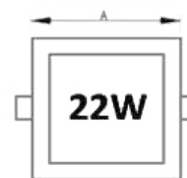

22W

275*275

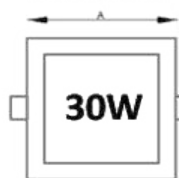

30W



DEEP PANEL

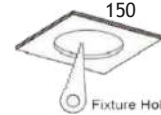
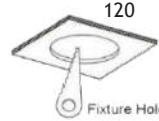
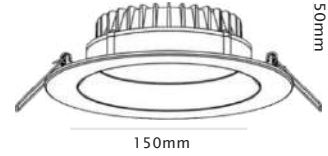
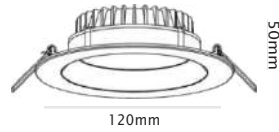

90-100 LW/W	BIS DRIVER	SKD SUPPLIER	2.5KV PROJECTION
----------------	---------------	-----------------	---------------------

■ PF.9PF.6



SPECIFICATION

12W

WATT -12W
DIMENSION OUTER(MM)-140mm
DIMENSION CUTOUT(MM)-120mm
COLOR TEMPERATURE-
 6500K,4000K,3000K,6500K,4000K,3000K
LUMENS-720
LED QUANTITY- 60

18W

WATT -18W
DIMENSION OUTER(MM)- 170mm
DIMENSION CUTOUT(MM)-150mm
COLOR TEMPERATURE-
 6500K,4000K,3000K,6500K,4000K,3000K
LUMENS-1080
LED QUANTITY-90

- **WARRANTY**-2YEARS
- **MATERIAL** - Aluminium
- **SHAPE** - Round
- **BEAMING ANGLE**- 120°
- **LED CHIP**-BRIDGELUXSMD0.2W
- **BODY COLOR**-White

RIMLESS PANEL

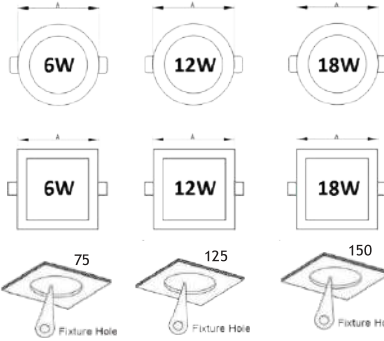

90-100 LW/W	BIS DRIVER	SKD SUPPLIER	2.5KV PROJECTION
----------------	---------------	-----------------	---------------------

■ PF.9PF.6

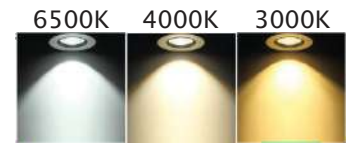

- **WARRANTY**-2YEARS
- **MATERIAL**-PC/Aluminium
- **SHAPE** - Round/Square
- **BEAMING ANGLE**- 120°
- **LED CHIP**-BRIDGELUXSMD0.2W
- **BODY COLOR**-White

SPECIFICATION

6W

WATT-6W
DIMENSION OUTER(MM)-95mm
DIMENSION CUTOUT(MM)-75mm
COLOR TEMPERATURE-CW-6500K,NW-4000K,WW3000K
LUMENS-720
LED QUANTITY-30

12W

WATT-12W
DIMENSION OUTER(MM)-145mm
DIMENSION CUTOUT(MM)-125mm
COLOR TEMPERATURE-6500K,4000K,3000K
LUMENS-1080
LED QUANTITY- 60

18W

WATT-18W
DIMENSION OUTER(MM)- 170mm
DIMENSION CUTOUT(MM)-150mm
COLOR TEMPERATURE-6500K,4000K,3000K
LUMENS-1620
LED QUANTITY-90



PC/PLASTIC PANEL

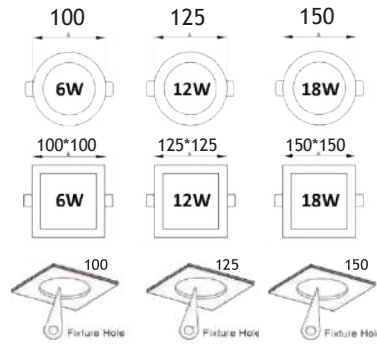

90-100 LW/W	BIS DRIVER	SKD SUPPLIER	2.5KV PROJECTION
----------------	---------------	-----------------	---------------------

■ PF.9PF.6

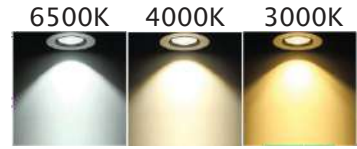

- WARRANTY-2YEARS
- MATERIAL -
- Polycarbonate
- SHAPE -
- Round/Square
- BEAMINGAN
- GLE-120°
- LEDCHIP-BRIDGELUXSMD0.2W
- BODYCOLOR-White

SPECIFICATION

6W

WATT- 6W
 DIMENSION OUTER (MM)-120mm
 DIMENSION CUTOUT (MM)-100mm
 COLOR TEMPERATURE-6500K,4000K,3000K
 LUMENS-720
 LED QUANTITY-50

12W

WATT -12W
 DIMENSION OUTER (MM)-145mm
 DIMENSION CUTOUT (MM)-125mm
 COLOR TEMPERATURE-6500K,4000K,3000K
 LUMENS-1080
 LED QUANTITY-110

18W

WATT- 18W
 DIMENSION OUTER (MM)-170mm
 DIMENSION CUTOUT (MM)-150mm
 COLOR TEMPERATURE-6500K,4000K,3000K
 LUMENS-1620
 LED QUANTITY-150

LED MOON ADJUSTABLE PANEL LIGHT

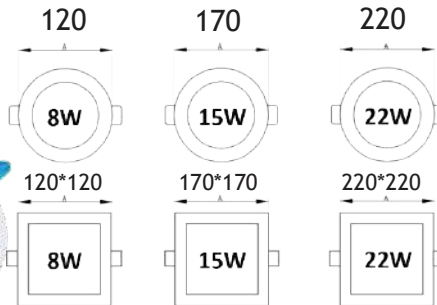

90-100 LW/W	BIS DRIVER	SKD SUPPLIER	2.5KV PROJECTION
----------------	---------------	-----------------	---------------------

■ PF.9PF.6

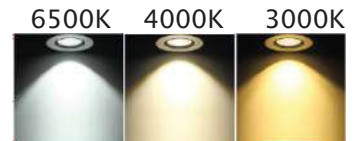

- WARRANTY-2YEARS
- MATERIAL-Polycarbonate
- SHAPE -
- Round
- REFLECTOR-
- Shinland
- BEAMING ANGLE-
- 150°
- LEDCHIP-BRIDGELUXSMD0.2W
- BODYCOLOR-White

SPECIFICATION

6W

WATT- 6W
 DIMENSION OUTER (MM)-65mm
 DIMENSION CUTOUT (MM)-50mm
 COLOR TEMPERATURE-6500K,4000K,3000K
 LUMENS-480
 LED QUANTITY-45

12W

WATT -12W
 DIMENSION OUTER (MM)-120mm
 DIMENSION CUTOUT (MM)-50-100
 COLOR TEMPERATURE-6500K,4000K,3000K
 LUMENS-1080
 LED QUANTITY-90

18W

WATT- 18W
 DIMENSION OUTER (MM)-150mm
 DIMENSION CUTOUT (MM)- 50-125
 COLOR TEMPERATURE-6500K,4000K,3000K
 LUMENS-1680
 LED QUANTITY-120



LED MOON COLOR PANEL



6500K 4000K 3000K



90-100 LW/W	BIS DRIVER	SKD SUPPLIER	2.5KV PROTECTION
----------------	---------------	-----------------	---------------------

PF.9PF.6

WARRANTY-2YEARS

MATERIAL-Polycarbonate

SHAPE-Round

BEAMINGANGLE-150°

LEDCHIP-BRIDGELUXSMD0.2W

BODYCOLOR-White

SPECIFICATION

6+3W

WATT-6+3W

DIMENSION OUTER(MM)-65mm

DIMENSION CUTOUT(MM)-50mm

COLOR TEMPERATURE-WH+BLUE,WH+PINK,WH+GREEN,WH+RED

LUMENS-480

LED QUANTITY -40+30

12+4W

WATT-12+4W

DIMENSION OUTER(MM)-120mm

DIMENSION CUTOUT(MM)-50-100mm

COLOR TEMPERATURE-WH+BLUE,WH+PINK,WH+GREEN,WH+RED

LUMENS-1080

LED QUANTITY-75+45

SLIM SURFACE

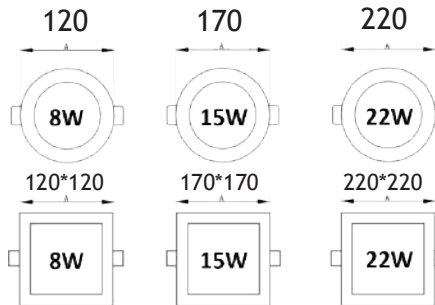

6500K 4000K 3000K



90-100 LW/W	BIS DRIVER	SKD SUPPLIER	2.5KV PROTECTION
----------------	---------------	-----------------	---------------------

PF.9PF.6

WARRANTY-2YEARS

MATERIAL-

Aluminium SHAPE-

Round/Square REFLECTOR -

Shinland BEAMINGANGLE-120°

LEDCHIP-BRIDGELUXSMD0.2W

BODYCOLOR-White

SPECIFICATION

8W

WATT-8W

DIMENSION OUTER (MM) -120mm

LENGTH(MM) -30mm

COLOR TEMPERATURE-6500K,4000K,3000K,REDGREENBLUEPINK

LUMENS-720

LED QUANTITY-40

15W

WATT-15W

DIMENSION OUTER(MM)-170mm

LENGTH(MM) -30mm

COLOR TEMPERATURE-6500K,4000K,3000K

LUMENS-1350

LED QUANTITY-75

22W

WATT-22W

DIMENSION OUTER(MM)-220mm

LENGTH(MM) -30mm

COLOR TEMPERATURE-6500K,4000K,3000K

LUMENS-1980

LED QUANTITY-110



FRAMELESS SURFACE

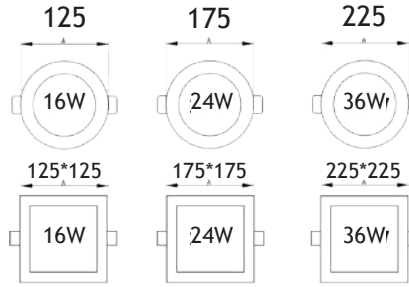

90-100 LW/W
BIS DRIVER
SKD SUPPLIER
2.5KV PROECTION

PF.9PF.6

6500K 4000K 3000K

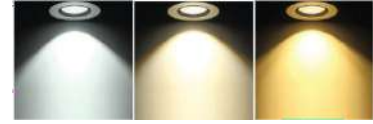

- WARRANTY-2YEARS
- MATERIAL -
- AluminiumSHAPE-
- Round/SquareBEAMIN
- GANGLE-120°
- LEDCHIP-BRIDGELUXSMD0.2W
- BODYCOLOR-White

SPECIFICATION

16W

WATT- 16W
DIMENSION OUTER (MM)-125mm
HEIGHT(MM)-35mm
COLOR TEMPERATURE-6500K,4000K,3000K
LUMENS-1440
LED QUANTITY-80

24W

WATT -24W
DIMENSION OUTER(MM)- 175mm
DIMENSION CUTOUT(MM)-35mm
COLOR TEMPERATURE -6500K,4000K,3000K
LUMENS-2160
LED QUANTITY-120

36W

WATT-36W
DIMENSION OUTER(MM)-225mm
DIMENSION CUTOUT(MM)-35mm
COLOR TEMPERATURE-6500K,4000K,3000K
LUMENS-3240
LED QUANTITY-180

LED CYLINDER SURFACE

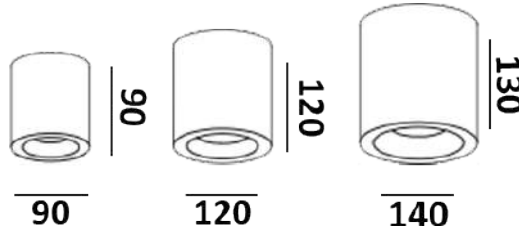

90-100 LW/W
BIS DRIVER
SKD SUPPLIER
2.5KV PROECTION

PF.9PF.6

6500K 4000K 3000K



- WARRANTY-2YEARS
- MATERIAL-
- AluminiumSHAPE -
- RoundBEAMINGANGLE-90°
- LEDCHIP-BRIDGELUXSMD0.2W
- BODYCOLOR-White/Black

SPECIFICATION

12W

WATT -12W
DIAMETER(MM)-90mm
LENGTH(MM)-90mm
COLOR TEMPERATURE-6500K,4000K,3000K
LUMENS-1080
LED QUANTITY-80

18W

WATT- 18W
DIAMETER(MM)-120mm
LENGTH(MM)-120mm
COLOR TEMPERATURE-6500K,NW-4000K,3000K
LUMENS-1620
LED QUANTITY-120

24W

WATT -24W
DIAMETER(MM)-140mm
LENGTH(MM)-130mm
COLOR TEMPERATURE-6500K,4000K,3000K
LUMENS-2160
LED QUANTITY-180



COB MOVABLE DOWNLIGHT



90-100 LW/W	BIS DRIVER	SKD SUPPLIER	2.5KV PROECTION
----------------	---------------	-----------------	--------------------

▪ PF.9PF.6

6500K 5000K 4000K 3000K



- **WARRANTY-2YEARS**
- **MATERIAL-**
- Aluminium**SHAPE -**
- Round**FLECTOR -**
- Shinland**BEAMINGANGLE -38°**
- **BODYCOLOR-White/Black**

SPECIFICATION

4W

WATT-4W
DIMENSIONCUTOUT(MM)-55mm
LENGTH(MM)-40mm
COLORTEMPERATURE-6500K,5000K,4000K,3000K
LUMENS-360

9W

WATT-9W
DIMENSION CUTOUT(MM)-75mm
LENGTH(MM)-50mm
COLORTEMPERATURE-6500K,5000K,4000K,3000K
LUMENS-810

15W

WATT-15W
DIMENSIONCUTOUT(MM)-95mm
LENGTH(MM)-60mm
COLORTEMPERATURE-6500K,5000K,4000K,3000K
LUMENS-1350

24W

WATT-24W
DIMENSIONCUTOUT(MM)-125mm
LENGTH(MM)-70mm
COLORTEMPERATURE-6500K,5000K,4000K,3000K
LUMENS-2160

36W

WATT-36W
DIMENSIONCUTOUT(MM)-140mm
LENGTH(MM)-80mm
COLORTEMPERATURE-6500K,5000K,4000K,3000K
LUMENS-3240

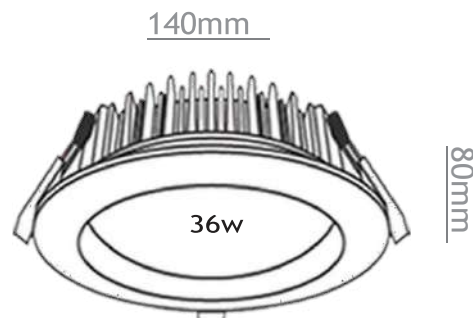
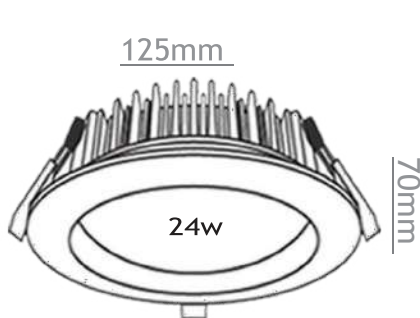
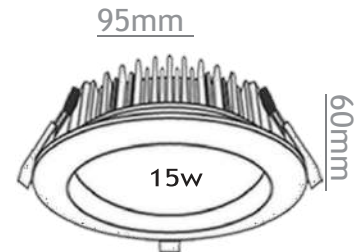
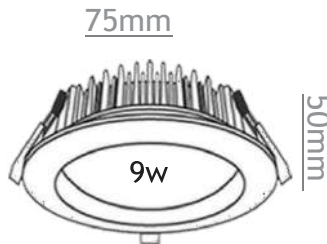
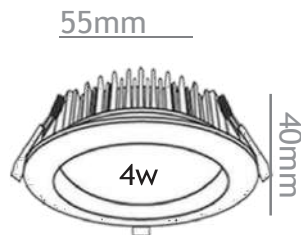



COB DEEP DOWNLIGHT

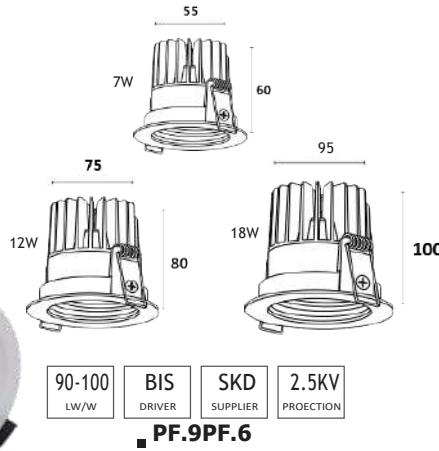

- WARRANTY-2YEARS
- MATERIAL- Aluminium
- SHAPE - Round
- REFLECTOR - Shinland
- BEAMINGANGLE -38°
- BODYCOLOR-White/Black

SPECIFICATION

7W

WATT-7W
 DIMENSIONCUTOUT(MM)-55mm
 LENGTH(MM)-60mm

COLORTEMPERATURE-6500K,5000K,4000K,3000K
 LUMENS-360

12W

WATT-12W
 DIMENSION CUTOUT(MM)-75mm
 LENGTH(MM)-80mm

COLORTEMPERATURE-6500K,5000K,4000K,3000K
 LUMENS-1080

18W

WATT-18W
 DIMENSIONCUTOUT(MM)-95mm
 LENGTH(MM)-100mm

COLORTEMPERATURE-6500K,5000K,4000K,3000K
 LUMENS-1620

COB DEEP DOWNLIGHT WITH REFLECTOR

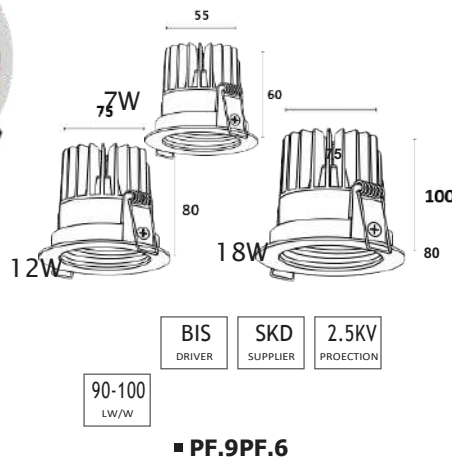

- WARRANTY-2YEARS
- MATERIAL - Aluminium
- SHAPE - Round
- REFLECTOR - Shinland
- BEAMINGANGLE-38°
- BODYCOLOR-White/Black
- REFLECTORCOLOR- RoseGold,

SPECIFICATION

7W

WATT-7W
 DIMENSIONCUTOUT(MM)-65mm
 LENGTH(MM)-60mm

COLORTEMPERATURE-6500K,5000K,4000K,3000K
 LUMENS-360

12W

WATT-12W
 DIMENSION CUTOUT(MM)-75mm
 LENGTH(MM)-80mm

COLORTEMPERATURE-6500K,5000K,4000K,3000K
 LUMENS-1080

18W

WATT-18W
 DIMENSION CUTOUT(MM)-75mm
 LENGTH(MM)-80mm

COLORTEMPERATURE-6500K,5000K,4000K,3000K
 LUMENS-1620



COB CYLINDER SURFACE



8W

15W

24W

6500K

5000K

4000K

3000K

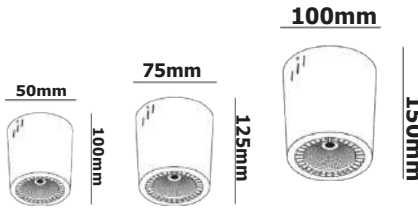

90-100 LW/W	BIS DRIVER	SKD SUPPLIER	2.5KV PROJECTION
----------------	---------------	-----------------	---------------------

■ PF.9PF.6

- WARRANTY-2YEARS
- MATERIAL- Aluminium
- SHAPE - Round
- REFLECTOR - Shinland
- BEAMING ANGLE -38°
- BODYCOLOR-White/Black
- REFLECTORCOLOR-ROSEGOLD/BLACK

SPECIFICATION

8W

WATT-8W
DIAMETER (MM)-50mm
LENGTH(MM)-100mm
COLORTEMPERATURE-6500K,5000K,4000K,3000K
LUMENS-120

15W

WATT-15W
DIAMETER(MM)-75mm
LENGTH(MM)-125mm
COLORTEMPERATURE-6500K,5000K,4000K,3000K
LUMENS-1350

24W

WATT-24W
DIAMETER(MM)-100mm
LENGTH(MM)-150mm
COLORTEMPERATURE-6500K,5000K,4000K,3000K
LUMENS-2160

COB TRACK/WALLLIGHT



12w

24w

36w



90-100 LW/W	BIS DRIVER	SKD SUPPLIER	2.5KV PROJECTION
----------------	---------------	-----------------	---------------------

■ PF.9PF.6

- WARRANTY-2YEARS
- MATERIAL- Aluminium
- SHAPE - Round
- BEAMING ANGLE - 38°
- BODYCOLOR-Black

SPECIFICATION

12W

WATT-12W
DIAMETERROUTER(MM)-55mm
LENGTH(MM)-145mm
COLORTEMPERATURE-6500K,5000K,4000K,3000K
LUMENS-1050

24W

WATT-24W
DIAMETERROUTER(MM)-65mm
LENGTH(MM)-160mm
COLORTEMPERATURE-6500K,5000K,4000K,3000K
LUMENS-2160

36W

WATT-36W
DIAMETERROUTER(MM)-75mm
LENGTH(MM)-180mm
COLORTEMPERATURE-6500K,5000K,4000K,3000K
LUMENS-3240



COB ZOOM LIGHT



- **WARRANTY**-2YEARS
- **MATERIAL**- Aluminium
- **SHAPE** - Round
- **BEAMING ANGLE** - 38°
- **BODYCOLOR**- White

SPECIFICATION

15W
WATT-15W
DIMENSIONCUTOUT(MM)-75mm
LENGTH(MM)-90mm
COLORTEMPERATURE-6500K,5000K,4000K,3000K
LUMENS-1350

30W
WATT-30W
DIMENSIONCUTOUT(MM)-120mm
LENGTH(MM)-135mm
COLORTEMPERATURE-6500K,5000K,4000K,3000K
LUMENS-2700

90-100 LW/W	BIS DRIVER	SKD SUPPLIER	2.5KV PROECTION
----------------	---------------	-----------------	--------------------

PF.9PF.6

COB CONCEAL TRACKLIGHT



- **WARRANTY**-2YEARS
- **MATERIAL**- Aluminium
- **SHAPE** - Round
- **BEAMING ANGLE** - 38°
- **BODYCOLOR**- White

SPECIFICATION

15W
WATT-15W
DIMENSIONCUTOUT(MM)-75mm
LENGTH(MM)-90mm
COLORTEMPERATURE-6500K,5000K,4000K,3000K
LUMENS-1350

30W
WATT-30W
DIMENSIONCUTOUT(MM)-115mm
LENGTH(MM)-135mm
COLORTEMPERATURE-6500K,5000K,4000K,3000K
LUMENS-2700

90-100 LW/W	BIS DRIVER	SKD SUPPLIER	2.5KV PROECTION
----------------	---------------	-----------------	--------------------

PF.9PF.6



COB CYLINDER ADJUSTABLE



- **WARRANTY**-2YEARS
- **MATERIAL**-Aluminium
- **SHAPE**-Round
- **COBCHIP**-
- **SANONCOB**BEAMING
- **ANGLE** - 38° **BODYCOLOR**- White

SPECIFICATION

15W

WATT - 15W
HEIGHT(TT)(MM) - 160mm
DIAMETER(MM) - 55mm
COLORTEMPERATURE - 6500K, 5000K, 4000K, 3000K
LUMENS - 1350

90-100 LW/W

BIS DRIVER

SKD SUPPLIER

2.5KV PROJECTION

PF.9PF.6

LINEAR LASER BLADE

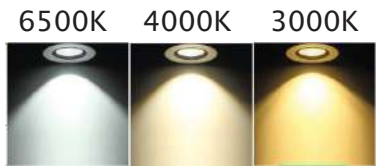

- **WARRANTY**-2YEARS
- **MATERIAL**-Polycarbonate
- **Type**-Conceal
- **SHAPE** -
- **Rectangle**REFLECTOR-
- **Black/Rosegold**BODY COLOR -
- **White/Black**COBCHIP- SANONLED2W

90-100 LW/W

BIS DRIVER

SKD SUPPLIER

2.5KV PROJECTION

PF.9PF.6

SPECIFICATION

10W

WATT-10W

DIMENSIONCUTOUT(MM)-50*45mm
LENGTH(MM)-35mm
COLORTEMPERATURE-6500K,4000K,3000K,
LUMENS-900

20W

WATT-20W

DIMENSIONCUTOUT(MM)-300*45MMmm
LENGTH(MM)-35mm
COLORTEMPERATURE-6500K,4000K,3000K
LUMENS-1800

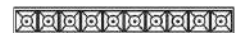
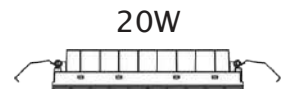

150*45MM

300*45MM



LINEAR SURFACE LIGHT

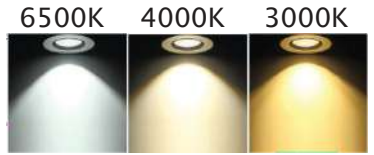

- **WARRANTY**-2YEARS
- **MATERIAL**-Polycarbonate
- **SHAPE**-Round
- **REFLECTOR**-
Black/Rosegold
- **BODY COLOR** -White/Black
- **COBCHIP**- SANONLED2W

SPECIFICATION

12W

WATT -12W
 TYPE-SURFACE
 DIMENSION CUTOUT (MM)-
 75MM OUTER COLOR TEMPERATURE-
 6500K,4000K,3000K LUMENS-1080

90-100 LW/W	BIS DRIVER	SKD SUPPLIER	2.5KV PROECTION
----------------	---------------	-----------------	--------------------

■ **PF.9PF.6**

LINEAR CONCEAL

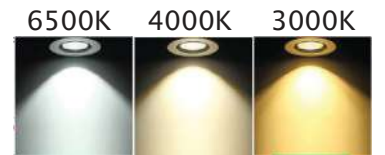

- **WARRANTY**-2YEARS
- **MATERIAL**-Polycarbonate
- **SHAPE**-Round
- **REFLECTOR**-
Black/Rosegold
- **BODY COLOR** -
White/Black
- **COBCHIP**-
SANONLED2W

SPECIFICATION

12W

WATT -12W
 TYPE-CONCEAL
 DIMENSION CUTOUT (MM) - 75 MM
 DIAMETER COLOR TEMPERATURE - 6500K,
 4000K , 3000K, LUMENS-1080

90-100 LW/W	BIS DRIVER	SKD SUPPLIER	2.5KV PROECTION
----------------	---------------	-----------------	--------------------

■ **PF.9PF.6**



Following Products Available In 3in1, CCT Adjustable, Tunable & Dimmable with Remote & Switch

SLIM PANEL



8W 15W

PLASTIC PANEL



15W

SLIM SURFACE



8W 15W

LINEARBLADE



12W

COBMOVABLEDOWNLIGHT



7W 15W 24W

CYLINDER



8W 15W

COB DEEP DOWNLIGHT COB DEEP DOWNLIGHT (reflector) COB CYLINDER ADJUSTABLE



7W12W 18W



7W12W 18W



15W



CERTIFICATES



We are CE, ROHS, ISO Certified which ensure our led are one of the best quality and safe to use. .We are also Registered with MSME & Government Procurement portal GEM.

Certificate of Compliance

We hereby declare that the technical file of product complied with Low Voltage Directive (LVD) (2014/35/EU)

Name : HYLUMEN INDUSTRIES
Address : PLOT NO. 804/2267, KHANDAGIRI CAVE ROAD, PO/PS - KHANDAGIRI, BHUBANESWAR, DIST- KHORDA, PIN- 751030, ODISHA, INDIA

Product : MANUFACTURING OF LED LIGHTING, LED STREET LIGHT, LED FLOOD LIGHT, LED EVENT LIGHT, LED BAR LIGHT, LED TUBE LIGHT, LED BLUB, LED RAY LIGHT, LED SOLAR LIGHT, LED DECORATIVE LIGHT, LED DOWN LIGHT, LED SPOT LIGHT, LED SURFACE LIGHT, LED INDUSTRIAL LIGHT, LED CEILING LIGHT, LED DISCHARGE LIGHT, TUBE ELECTRICALS FOR LIGHTING, DIVING LIGHT, FORRY LIGHTS, FILAMENTS FOR LIGHTING, FLASHLIGHT, LANTERANCE FOR LIGHTING, LIGHT BULBS, LIGHTING APPARELS AND INSTALLATION LIGHT, LUMINOUS TUBES FOR LIGHTING, SEARCH LIGHTS, TOUCHES FOR LIGHTING LED HI-BAY LIGHT

The Certification body has performed an audit of the above product quality system covering the design, manufacture and final inspection of the certified product. The quality system has been assessed, approved and is subject to continuous surveillance according to the Low Voltage Directive (LVD) (2014/35/EU)

This certificate is issued under the following conditions:

- It applies only to the quality system maintained in the manufacture of above referenced models and it does not substitute the design or type-examination procedures, if required.
- The certificate holder shall visit the manufacturing conditions or the quality system as changed.
- The certificate validity is conditional on positive results of surveillance audits.
- After fulfilling the relevant EU legislations, the manufacturer shall affix to each device, or the referenced models
- The CE mark as shown above can be used within the responsibility of the manufacturer. After completion of an EC Declaration of Conformity and compliance with all relevant EC Directives. The agreement is based on a single evaluation of one sample of above mentioned product. It does not imply an assessment of the whole production.

Certificate Number : EC021ES454
 To Verify this certificate please visit at www.eccert.co.uk

Initial Date : 26th June 2021
 Issue Date : 26th June 2021
 Certificate Expiry Date : 25th June 2024

Auth. Signatory
 Excellence Certification Services UK Limited (ECS UK)

CE Marking
 Excellence Certification Services UK Limited (Accreditation No. CBM78P)
 Suite 30, 78-88 London, EC1N 6PN, UK. Email: info@eccert.co.uk & Website: www.eccert.co.uk
 Validity of this certificate is subject to successful completion of surveillance audits on or before of due date. If surveillance audit is not conducted, this certificate shall be suspended/revoked. Certificate is the property of ECS UK and shall be returned immediately when demanded.

CE CERTIFIED

Certificate of Registration

HYLUMEN INDUSTRIES

PLOT NO. 804/2267, KHANDAGIRI CAVE ROAD, PO/PS - KHANDAGIRI, BHUBANESWAR, DIST-KHORDA, PIN-751030, ODISHA, INDIA

has been assessed and Certified by Otabu Certification Pvt. Ltd. as meeting the requirements of:

ISO 9001:2015
Quality Management System

For the following scope of activities:

MANUFACTURING OF LED LIGHTING, LED STREET LIGHT, LED FLOOD LIGHT, LED EVENT LIGHT, LED BAR LIGHT, LED TUBE LIGHT, LED BLUB, LED RAY LIGHT, LED SOLAR LIGHT, LED DECORATIVE LIGHT, LED DOWN LIGHT, LED SPOT LIGHT, LED SURFACE LIGHT, LED INDUSTRIAL LIGHT, LED CEILING LIGHT, LED DISCHARGE LIGHT, TUBE ELECTRICALS FOR LIGHTING, DIVING LIGHT, FORRY LIGHTS, FILAMENTS FOR LIGHTING, FLASHLIGHT LANTERANCE FOR LIGHTING, LIGHT BULBS, LIGHTING APPARELS AND INSTALLATION LIGHT, LUMINOUS TUBES FOR LIGHTING SEARCH LIGHTS TOUCHES FOR LIGHTING LED HI-BAY LIGHT

Issue No : 01
 Date of Certification: 25 June 2021
 1st Surveillance Due: 24 June 2022

Revision No () : NA
 2nd Surveillance Due: 24 June 2023
 Certificate Expiry: 24 June 2024
 (subject to the company maintaining systems to the requirements)

Certificate No:- 062G04621
 To Verify this Certificate please visit at www.otabucert.com

Dr. Anita Gupta
 Director

*Validity of this certificate is subject to successful completion of surveillance audit on or before due date. In case surveillance audit is not allowed to be conducted, this certificate shall be suspended/revoked. This Certificate is the Property of Otabu Certification Pvt. Ltd. and shall be returned immediately upon request.
 Otabu Certification Pvt. Ltd., ISO 9001:2015, Plot No. 804/2267, Khandagiri, Bhubaneswar, Odisha, India.
 Email:- info@otabucert.com website:- www.otabucert.com

ISO 9001:2015 CERTIFIED

Certificate of Compliance

Manufacturer

HYLUMEN INDUSTRIES

PLOT NO. 804/2267, KHANDAGIRI CAVE ROAD, PO/PS - KHANDAGIRI, BHUBANESWAR, DIST- KHORDA, PIN- 751030, ODISHA, INDIA

MANUFACTURING OF LED LIGHTING, LED STREET LIGHT, LED FLOOD LIGHT, LED EVENT LIGHT, LED BAR LIGHT, LED TUBE LIGHT, LED BLUB, LED RAY LIGHT, LED SOLAR LIGHT, LED DECORATIVE LIGHT, LED DOWN LIGHT, LED SPOT LIGHT, LED SURFACE LIGHT, LED INDUSTRIAL LIGHT, LED CEILING LIGHT, LED DISCHARGE LIGHT, TUBE ELECTRICALS FOR LIGHTING, DIVING LIGHT, FORRY LIGHTS, FILAMENTS FOR LIGHTING, FLASHLIGHT LANTERANCE FOR LIGHTING, LIGHT BULBS, LIGHTING APPARELS AND INSTALLATION LIGHT, LUMINOUS TUBES FOR LIGHTING SEARCH LIGHTS TOUCHES FOR LIGHTING LED HI-BAY LIGHT

This to state the above mentioned product is in compliance with RoHS Directive General 92/59/EEC on the restriction of the use of certain Hazardous Substances

Statement: This certificate declares that the product type/model described above complies with the mentioned above European standard (s).

Remarks: This certificate of complies is based on the evaluation of sample of the above mention products. It does not imply and assessment of the mass production of the product. This certificate holder may use this certificate in connection with the said report. The certification body should be informed (previous of technical file) for any modifications or alterations made to the aforementioned product type(s), including design and manufacture and/or extension to the existing scope of application.

Certificate Number : EC021PO121
 To Verify this certificate please visit at www.eccert.co.uk

Initial Date : 26th June 2021
 Issue Date : 26th June 2021
 Certificate Expiry Date : 25th June 2024

Auth. Signatory
 Excellence Certification Services UK Limited (ECS UK)

RoHS
 Excellence Certification Services UK Limited (Accreditation No. CBM78P)
 Suite 30, 78-88 London, EC1N 6PN, UK. Email: info@eccert.co.uk & Website: www.eccert.co.uk
 Validity of this certificate is subject to successful completion of surveillance audits on or before of due date. If surveillance audit is not conducted, this certificate shall be suspended/revoked. Certificate is the property of ECS UK and shall be returned immediately when demanded.

ROHS CERTIFIED

भारत सरकार
 Government of India
 सूक्ष्म, लघु एवं मध्यम उद्यम विभाग
 Ministry of Micro, Small and Medium Enterprises

UDYAM
REGISTRATION CERTIFICATE

Our small hands to make you LARGE!

UDYAM REGISTRATION NUMBER	UDYAM-OD-19-0010464
NAME OF ENTERPRISE	M/S HYLUMEN INDUSTRIES
TYPE OF ENTERPRISE*	MICRO
MAJOR ACTIVITY	MANUFACTURING
SOCIAL CATEGORY OF ENTREPRENEUR	GENERAL
NAME OF UNIT	M/S HYLUMEN INDUSTRIES (Name of Unit)
Production/Block No.	001107
Address/Block	KHANDAGIRI CAVE ROAD
Post/Block/Post Office	BHUBANESWAR
Pin Code	751030
Mobile Number	9437878787
Website	HYLUMENINDUSTRIES.COM
DATE OF INCORPORATION/REGISTRATION OF ENTERPRISE	23/03/2017
DATE OF COMMENCEMENT OF PRODUCE/PROVISIONS	01/04/2017
NATIONAL INDUSTRY CLASSIFICATION CODE(S)	32.91 (32.91.01)
DATE OF UDYAM REGISTRATION	25/06/2021

* In case of production (operational) unit of an enterprise, the benefit of the Government Schemes will be available on the production of "Notification No. S.15 (2019) dated 18.06.2019 issued by the MoSMEs.

Disclaimer: This is a computer generated document, no signature required. Printed from www.registration.gov.in & Date of printing: 25/06/2021

For any assistance, you may contact:

- Director Industries Centre: KHORDA (KHORDA)
- MSME-DE: CUTTACK (KHORDA)

*Web: www.registration.gov.in | www.msme.gov.in | www.udyamregistration.gov.in

BE A CHAMPION with the Ministry of MSME

MSME REGISTERED



Hylumen LED

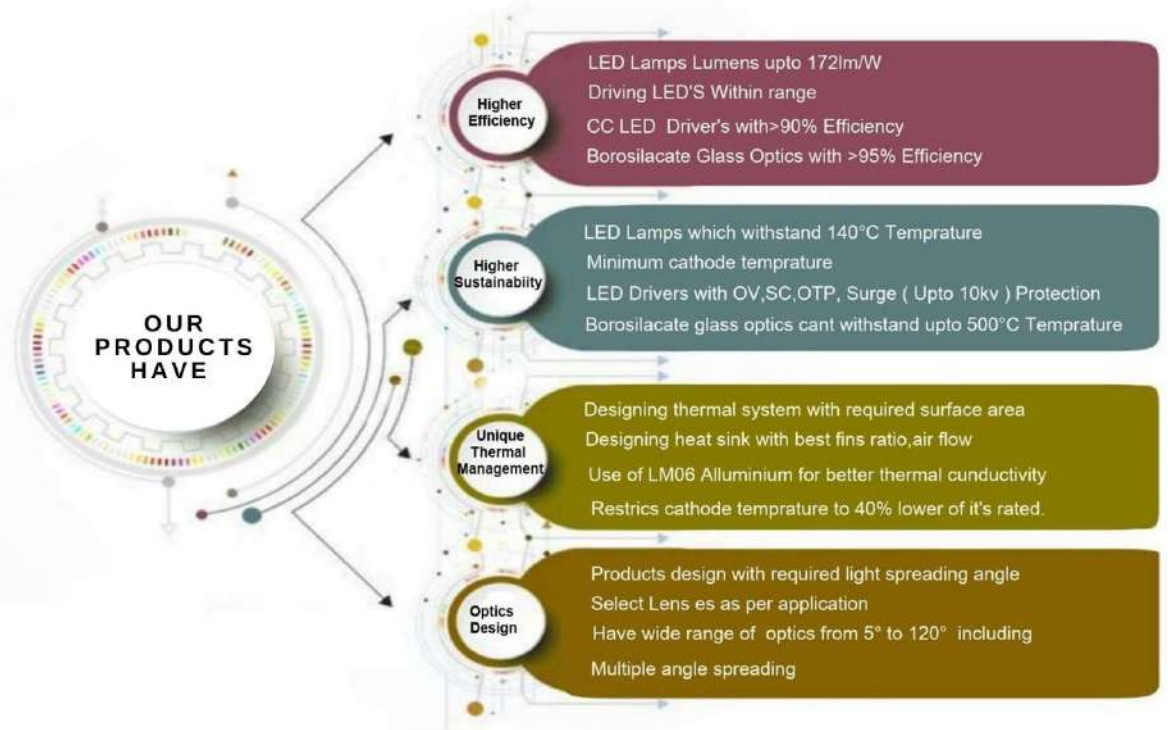

Hylumen LED



HYLUMEN INDUSTRIES

MANUFACTURER OF OUTDOOR, INDOOR, INDUSTRIAL & COMMERCIAL LED LIGHTS

WWW.HYLUMEN.COM

Email: hylumen@hylumen.com

Website: www.hylumen.com

Mo:7854870502/8908029390

Address: Plot no 804/2265, Khandagiri Cave Road, Bhubaneswar India 751030